





# BUILDING ACCESSORIES

The Key to Our Success: The Passionate Pursuit of Yours!

ITEM	PART ID	DESCRIPTION	SIZE	WEIGHT
<b>CLOSURE STRIPS*</b>	CL	Outside Closure Strips 	1" x 36"	.03 #
	ICL	Inside Closure Strips   Also available in Hi-Rib There is adhesive on the flat side of both the outside and inside closure strips	1" x 36"	.03 #
<b>VENTED CLOSURES*</b>	CLV	Vented Closure Strips   There is adhesive on the flat side of both the outside and inside closure strips	2"x36"	.05 #
<b>FLAT SHEETS</b>	FLS	40 7/8" wide 	10'6" long	22.89 #
<b>CUPOLAS*</b> 	CU24	24"x24" Cupola Roof, Walls, Base		50 #
	CU36	36"x36" Cupola Roof, Walls, Base		55 #
	CU48	48"x48" Cupola Roof, Walls, Base		60 #
	WE24	24" Weathervane		5 #
	WE30	30" Weathervane		5 #

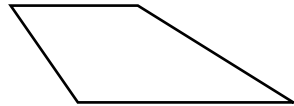
# BUILDING ACCESSORIES

The Key to Our Success: The Passionate Pursuit of Yours!

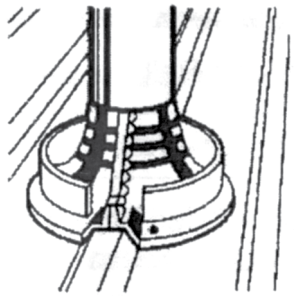
ITEM	PART ID	DESCRIPTION	SIZE	WEIGHT
<b>ROOF JACKS*</b>	RJ3	#3 Roof Jack	¼" - 5"	.50 #
	RJ5	#5 Roof Jack	4¼" - 7½"	.95 #
	RJ8	#8 Roof Jack	7" - 13"	1.55 #
	RJ9	#9 Roof Jack	10" - 18"	2.56 #
				
<b>RETROFIT ROOF JACKS*</b>	RRJ1	#1 Retrofit Roof Jack (Zip-Up)	¾" - 2¾"	.50 #
	RRJ2	#2 Retrofit Roof Jack (Zip-Up)	2" - 7¼"	.95 #
				.75 #
				1.25 #
				1.75 #
				2.89 #
<b>HIGH TEMPERATURE ROOF JACK</b>	RJ3H	#3 Roof Jack	¼" - 4"	.75 #
	RJ5H	#5 Roof Jack	4" - 7"	1.25 #
	RJ8H	#8 Roof Jack	7" - 13"	1.75 #
	RJ9H	#9 Roof Jack	10" - 18"	2.89 #

# BUILDING ACCESSORIES

The Key to Our Success: The Passionate Pursuit of Yours!

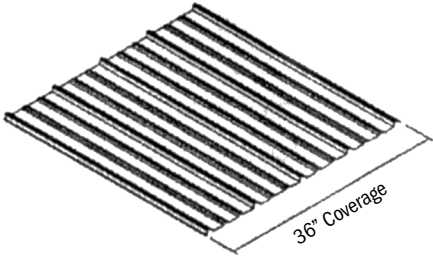
ITEM	PART ID	DESCRIPTION	SIZE	WEIGHT
<b>REFLECTIVE INSULATION*</b>	I	4' Foil Bubble Bubble Foil	4'x125'	38 #
	ID6F	6' Foil Bubble Bubble Foil	6'x125'	57 #
	IWP	4' Foil Bubble Bubble White Vinyl Polyethylene	4'x125'	38 #
	ID6WP	6' Foil Bubble Bubble White Vinyl Polyethylene	6'x125'	57 #
	IS6WP	6' Foil Bubble White Vinyl Polyethylene	6'x125'	38 #
<b>METAL BUILDING VINYL BACK FIBERGLASS INSULATION</b>	R196	R-19 6" Vinyl Back Fiberglass	4'x50'	164 #
	R103	R-10 3" Vinyl Back Fiberglass	4'x100"	87 #
	R624	R-6 2" Vinyl Back Fiberglass	4'x100"	75 #
	R626	R-6 2" Vinyl Back Fiberglass	6'x100"	125 #
<b>INSULATION TAPE</b>	IT	Foil Tape Roll	125'	1 #
	ITWP	White Tape Roll	125'	1 #
	DST	Double Sided Tape 1½"	180'	1 #
<b>POLYCARBONATE PANELS &amp; RIDGE CAP*</b>	Clear- PCP White- PWP	Polycarbonate Panels  Available in Low Rib Available in White or Clear	12' Long	8 #
	Clear- PRC White- PRCW	Polycarbonate Ridge Cap Available in White or Clear	24' Wide 10'4" Long	5 #

# BUILDING ACCESSORIES

The Key to Our Success: The Passionate Pursuit of Yours!

ITEM	PART ID	DESCRIPTION	SIZE	WEIGHT
<b>TOUCH-UP PAINT</b>	TPM	Touch Up Paint - Spray Can	3.4 oz/ can	1#
	TPP	Touch Up Paint - Pen Spray cans cannot be shipped via Air Touch-up paint available in all colors listed on the color chart	.5 oz/pen	
<b>MAGNETIC SOCKET</b>	N/A	1/4" One Piece		.5 #
	N/A	5/16" One Piece		1#
<b>BUTYL TAPE</b>	BUTYL	3/32" x 1/2" Butyl Tape	50' Roll	1 #
<b>EMSEAL*</b>	EMSEAL	Expandable Closure (expands to 1 1/2")	13.12' Roll	1 #
<b>RETRO EASE (RE2)*</b>	RE300	Retro Ease (goes over Shingles instead of wood)	300' per box	10 #
<b>CAULKING*</b>	GEOCEL	Geocel 2300 (caulking to match colors of metal)	1 Tube	1 #
<b>TURBO SHEAR</b>	MTSHD	MALCO Turbo Shear HD		5 #

# MANDOORS

The Key to Our Success: The Passionate Pursuit of Yours!

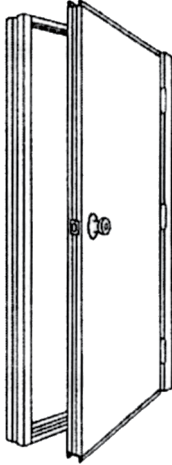
ITEM	PART ID	DESCRIPTION	SIZE	WEIGHT
<b>HARVARD MANDOORS*</b>    <b>ALL STEEL FRAME &amp; DOOR</b>  Available in White	HM	Harvard Mandoor	3' x 6'8"	160 #
	HMG	Harvard Mandoor with 9 Lite Glass (Specify Hand)	3' x 6'8"	165 #
	HM4	Harvard Mandoor	4' x 6'8"	215 #
	HM4G	Harvard Mandoor with 9 Lite Glass (Specify Hand)	4' x 6'8"	220 #
	HM6	Double Harvard Mandoor	6' x 6'8"	320 #
	HM6G	Double Harvard Mandoor with 9 Lite Glass (specify Hand)	6' x 6'8"	330 #
<b>PLYCO MANDOORS*</b>  Available in White	P99	PLYCO Economy Series 99E	3' x 6'8"	120 #



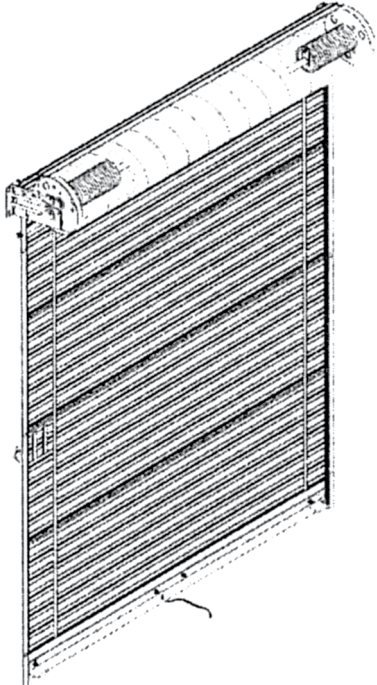

# ROLLUP DOORS

The Key to Our Success: The Passionate Pursuit of Yours!

ROLLUP DOORS*	DESCRIPTION	WEIGHT
 <p><b>NOTE:</b></p> <ol style="list-style-type: none"> <li>1. Please specify wood, steel or masonry application.</li> <li>2. Door includes all hardware &amp; track.</li> <li>3. Optional Pantheon Opener available on all doors.</li> <li>4. Door color is white, unless otherwise specified. Optional colors are available at an additional charge (shipping time will vary).</li> </ol>	<p>4 X 8 Mini Rollup Door            6 X 8 Mini Rollup Door            8 X 8 Mini Rollup Door            9 X 8 Mini Rollup Door            10 X 10 Mini Rollup Door</p>	<p>80 #            120 #            160 #            180 #            250 #</p>

# FASTENER GUIDE FOR SCREWS

The Key to Our Success: The Passionate Pursuit of Yours!

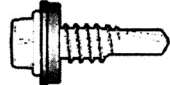
DESCRIPTION	SIZE	FINISH	APPLICATION	QUANTITY
 Self-Driller (Tek screws)*	1" Long Head Size 5/16"	Painted Or Galvanized	Metal to Metal	Bags of 250 or 500
 Wood Screw*	1" Long 1½" Long 2" Long Head Size 1/4"	Painted Or Galvanized	Wood to Metal	Bags of 250 or 500
 Stitch*	1" Long Head Size 5/16"	Painted Or Galvanized	Light Gauge Metal to Light Gauge Metal	Bags of 250 or 500

Note: We recommend using 1 bag of screws per 100 ft of metal.

## Typical Screw Pattern

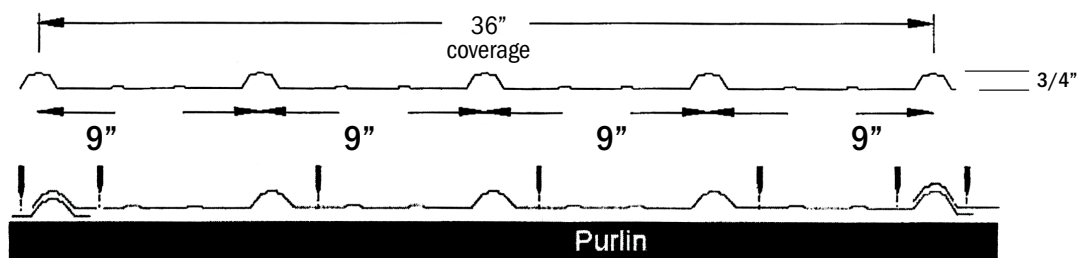

PortaGrace Mfg. recommends the use of painted or galvanized screws as a fastening method for our metal panels. Screws should have a driller tip with a flat rubber washer being careful to apply sufficient torque to seat the washer – do not overdrive the fastener.

The correct screw gun is also important to the proper installation of self-drilling screws. A tool with the appropriate speed and torque settings (as recommended

by the fastener manufacturer) will help prevent fastener thread strip-out and possible damage to the panel or its coating. Bear down only hard enough on the screw gun to engage clutch. This prevents excess friction and burn out of the drill point. Correct pressure will allow the screw to drill and tap without binding.

# SLIDING DOOR COMPONENTS

*The Key to Our Success: The Passionate Pursuit of Yours!*



*CLC*

## CENTER LATCH WITH 17" CHAIN

---

Secures bi-parting doors  
Sliding chain provides maximum security

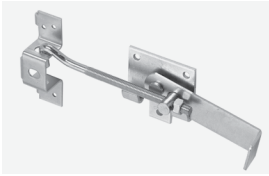

*JL7*

## JAMB LATCH (7")

---

7" Hook pulls door securely against jamb with a cam action



*DPW*

## DOOR PULL (white)

---

Large design 1-3/4" W x 6-5/8"L  
White poly coated  
1000 Spray Hours



*SH*

## SHORT HANGERS

---

Used for mounting track system without cover



*LH*

## LONG HANGERS

---

Used for mounting with standard cover trim  
Use one support for every 2' of track cover



*DTB*

## DOUBLE TRACK BRACKET WITH LONG HANGER

---

A heavy duty bracket that allows for a double mounted track  
Use one bracket for every 2' of track cover



*SPLC*

## SPLICE COLLAR

---

Enables splicing of multiple track sections with perfect alignment



*TREC*

## TRACK END CAP

---

Adds a finished look to track system creating a bird-proof barrier  
Includes a set of 2 caps



# SLIDING DOOR COMPONENTS

The Key to Our Success: The Passionate Pursuit of Yours!

## ADJUSTABLE DOOR STOP (white)

ADSW

Adjustable design for multiple positions  
White poly coated  
1000 salt spray hours

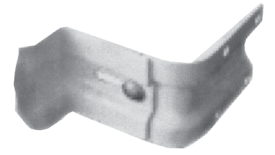

## GUIDE RAIL WITH BRACKET (6')

GRB6

Holds sliding door close to building using bottom rail system



## OFFSET ADJUSTABLE STAY ROLLER

OASR

Galvanized steel bracket  
3 mounting slots for adjustment  
Delrin guide wheel



## TROLLEY SET (9.5")

TS9

Delrin 4-way adjustable trolley  
Includes 9-1/2" offset bolt  
Includes a set of 2



## SLIDING DOOR TRACK

8', 10' 12' 14' 16', 18', 20'  
14 Gauge Steel  
Round key slot design for easy mounting every 2' with mounting brackets  
Splice collars lock track sections together in perfect alignment  
End caps provide bird proofing  
Round design is self-cleaning and allows for easy opening of doors



## SLIDING DOOR FRAME RAILS (1.5" wide)

### **Bottom Box Rail**

8', 10' 12' 14' 16'

### **Vertical Side Rail (male)**

8', 10' 12' 14' 16'

### **Vertical H-Rail (female)**

8', 10' 12' 14' 16'

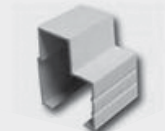

# SLIDING DOOR & TRACK COMPONENTS

The Key to Our Success: The Passionate Pursuit of Yours!

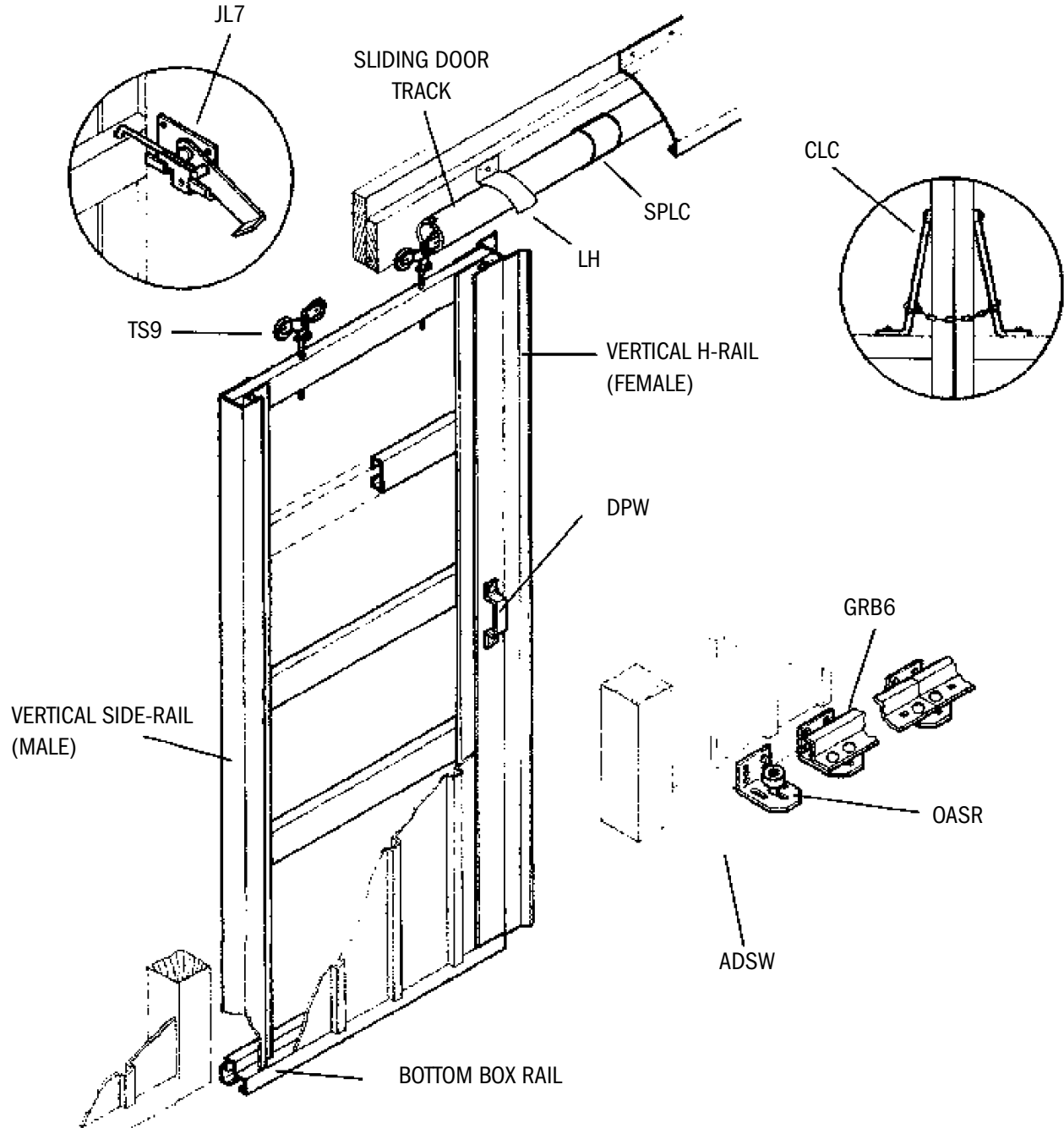

# SINGLE SLIDING DOOR KITS

The Key to Our Success: The Passionate Pursuit of Yours!

## SINGLE SLIDING DOOR KITS

OPENING SIZE (W X H)	TRACK Pcs. Length	Splice Collar	END CAPS (Pair)	LONG HANGERS	TROLLEY SETS (9.5") (Pair)	DOOR PULL	OFF-SET ADJ. STAY ROLLERS	ADJ. DOOR STOP	JAMB LATCH (7")
10 X 10	2 10	1	1	11	1	1	1	2	2
12 X 10	2 12	1	1	13	1	1	1	2	2
14 X 10	2 14	1	1	15	2	1	1	2	2
16 X 10	2 16	1	1	17	2	1	1	2	2
10 X 12	2 10	1	1	11	1	1	1	2	2
12 X 12	2 12	1	1	13	1	1	1	2	2
14 X 12	2 14	1	1	15	2	1	1	2	2
16 X 12	2 16	1	1	17	2	1	1	2	2
10 X 14	2 10	1	1	11	1	1	1	2	2
12 X 14	2 14	1	1	13	1	1	1	2	2
14 X 14	2 14	1	1	15	2	1	1	2	2
16 X 14	2 16	1	1	17	2	1	1	2	2

NOTE: Above does not include track cover

## KWIK FRAMES SETS

	MALE Pcs. Length		BOTTOM Pcs. Length	
	2	10	1	10
	2	10	1	12
	2	10	1	14
	2	10	1	16
	2	12	1	10
	2	12	1	12
	2	12	1	14
	2	12	1	16
	2	14	1	10
	2	14	1	12
	2	14	1	14
	2	14	1	16

# DOUBLE SLIDING DOOR KITS

The Key to Our Success: The Passionate Pursuit of Yours!

## DOUBLE SLIDING DOOR KITS

OPENING SIZE (W X H)	TRACK Pcs. Length	Splice Collar	END CAPS (Pair)	LONG HANGERS	TROLLEY SETS (9.5") (Pair)	DOOR PULL	OFF-SET ADJ. STAY ROLLERS	ADI. DOOR STOP	JAMB LATCH (7")
10 X 10	2	1	2	12	2	2	2	2	3
12 x 10	2	1	2	14	2	2	2	2	3
14 X 10	2	1	2	16	2	2	2	2	3
16 X 10	2	1	2	18	2	2	2	2	3
20 X 10	2	1	2	22	2	2	2	2	3
10 X 12	2	1	2	12	2	2	2	2	3
12 X 12	2	1	2	14	2	2	2	2	3
14 X 12	2	1	2	16	2	2	2	2	3
16 X 12	2	1	2	18	2	2	2	2	3
20 X 12	2	1	2	22	2	2	2	2	3
10 X 14	2	1	2	12	2	2	2	2	3
12 X 14	2	1	2	14	2	2	2	2	3
14 X 14	2	1	2	16	2	2	2	2	3
16 X 14	2	1	2	18	2	2	2	2	3
20 X 14	2	1	2	22	2	2	2	2	3

## KWIK FRAME SETS

MALE Pcs. Length	BOTTOM Pcs. Length		FEMALE Pcs. Length
3	10	1	10
3	10	1	10
3	10	1	10
3	10	1	10
3	10	2	10
3	12	1	12
3	12	1	12
3	12	1	12
3	12	1	12
3	12	2	12
3	14	1	14
3	14	1	14
3	14	1	14
3	14	1	14
3	14	2	14